

# RF SYSTEM FOR COMPACT MEDICAL PROTON SYNCHROTRON

Z. Fang, K. Endo, K. Egawa, S. Yamanaka, KEK, Tsukuba, Japan  
T. Hirashima, T. Fusato, Y. Cho, Denki Kogyo Co., Aikou-gun, Japan

## Abstract

The rf system has been developed for the compact medical proton synchrotron. The rf cavity consists of 2 cells loaded with 4 high-permeability magnetic alloy cores in each cell, and the 2 cells of rf cavity are driven by a push-pull power amplifier in parallel which is formed with two tetrode tubes 4CX35,000C. The rf system is operated in pulse mode. During the beam acceleration time of 5 ms, the rf frequency sweeps from 2.0MHz to 17.8MHz and the cavity voltage varies from 10.0kV to 1.6kV. The high power test of the rf system is being performed, and the required gap voltage has been successfully achieved. The performance of the rf system will be presented.

## INTRODUCTION

The compact proton synchrotron is being developed for the medical radiotherapy [1-2]. According to the lattice design of the machine, the proton synchrotron is operated in pulse mode with the beam acceleration time of 5ms [3-5]. In the pulse of 5ms, the bending magnet attains 3T, and the proton beam energy reaches 200MeV. The circumference of synchrotron is only 9.54m, so the beam acceleration system is required to have frequency sweeping from 2MHz to 17.8MHz, and maximal rf cavity voltage of 10kV, as shown in Fig. 1. Therefore, the key features of this rf system are the relatively wide bandwidth and the high acceleration gradient. The rf system has been designed and developed as shown in Fig. 2, and the above requirements have been successfully achieved.

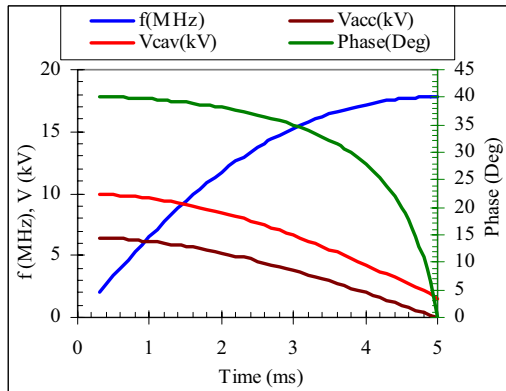

Figure 1: Required rf frequency, beam accelerating voltage, cavity voltage, and acceleration rf phase, as functions of acceleration time.

## RF CAVITY

The rf cavity consists of 2 cells loaded with 4 high-permeability magnetic alloy cores in each cell, as shown in Fig. 3. The cavity length is 400mm. The cavity

impedance is calculated by

$$Z_{cav} = \frac{1}{\frac{1}{j\omega(u' - ju'')L_0} + j\omega C_g}$$

where  $u = u' - ju''$  is the complex permeability of cores, and  $L_0 = \frac{u_0}{2\pi} h \ln \frac{b}{a} = 2 \times 10^{-7} \times h \ln \frac{b}{a}$ , where  $a$  and  $b$  are the inner and outer diameters of cores, and  $h$  is the core length.

The impedances at the two gaps have been measured. The average impedance of test results and the calculation results for gap capacitance of 24pF are shown in Fig. 4. It is shown that the test results agree with the calculation results very well. And for the cores used in this cavity, the measured average value of core permeability is  $u' = 1288f^{-0.81}$  and  $u'' = 3161f^{-0.81}$ , where  $f$  is in MHz.



Figure 2: RF cavity and power amplifier.

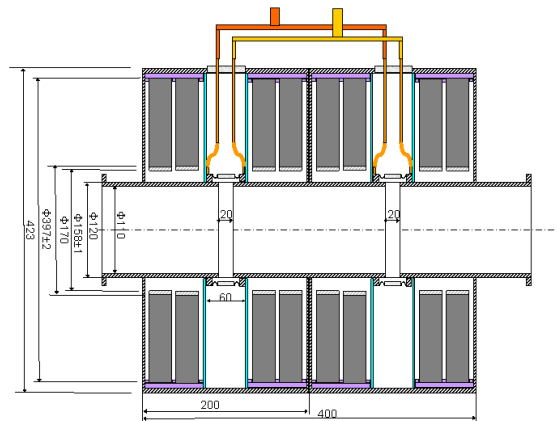
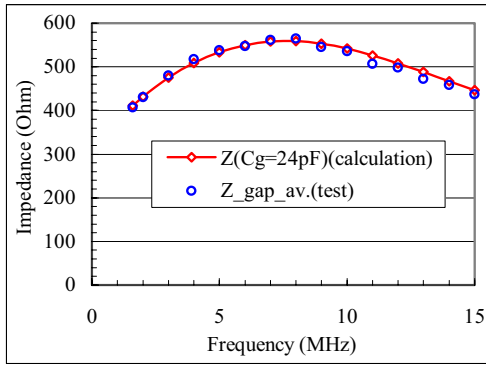

Figure 3: Structure of rf cavity.

## POWER AMPLIFIER

In the rf system, two tetrode tubes 4CX35,000C are used to form a push-pull amplifier to drive the two cells of rf cavity in parallel, as shown in Fig. 5. Each side of the cavity gaps is directly connected to the anodes of the two tubes through the DC blocking capacitors of 0.1uF.



a) Impedance amplitude

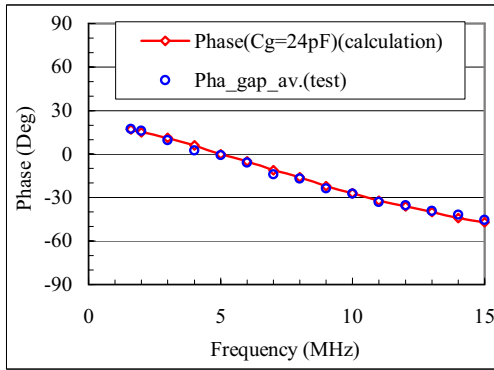

b) Impedance phase

Figure 4: Test and calculation results of cavity gap impedance.

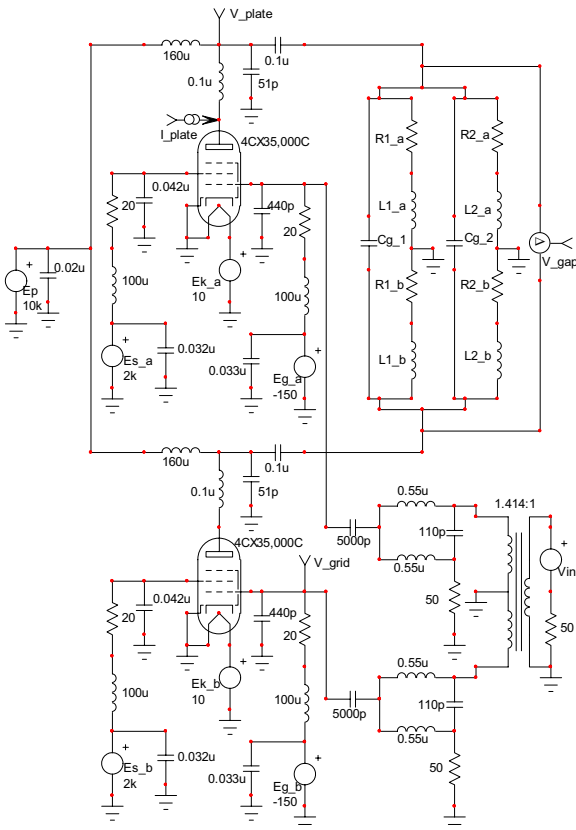

Figure 5: Circuit of rf system.

The input and output capacitances of the tube are 440pF and 51pF, respectively. All-pass network is applied to the input circuit for matching the tube's input capacitance [6]. The parts of the all-pass network have been adjusted carefully, and SWR of tube input circuit is obtained smaller than 1.15 in the whole operation frequency range.

A 2kW preamplifier T145-6346B (Thamway Co., LTD) has been developed and is used to drive the main amplifier.

## HIGH POWER TEST

We have taken the data of input power for getting the required gap voltage. Since there are 2 gaps in the rf cavity, the required gap voltage is half of the summation. Thus the maximal required gap voltage is 5kV. Fig. 6 shows the experiment results. From the test results, we can see that the rf system can successfully produce the required gap voltage.

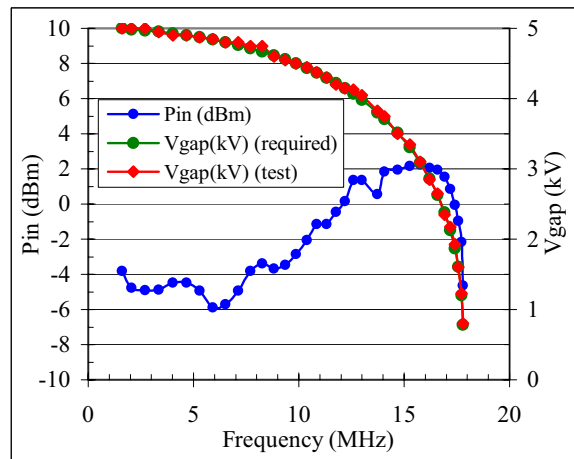

Figure 6: Input power for getting required gap voltage.

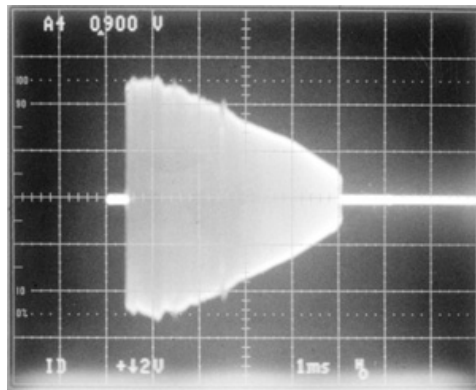

Figure 7: Waveform of gap voltage with rf frequency sweeping from 2.0MHz to 17.8MHz and amplitude envelope of  $5\cos(90\pi t)$ kV.

The above data of the input power for obtaining the required gap voltage is used as the initial input data of the rf control system based on a DDS signal generator. The high power test with the rf control system has been performed with feedback off, and a waveform of gap

voltage with rf frequency sweeping from 2.0MHz to 17.8MHz and amplitude envelope of  $5\cos(90\pi t)$ kV has been successfully obtained, as shown in Fig. 7. Soon we will do more experiments carefully to carry out the waveform clearer.

Also we have taken the data of maximal gap voltage produced by the rf system, as shown in the red curve in Fig. 8. It shows that from 13MHz to 17MHz, almost no margin exists between the maximal voltage and the required voltage.

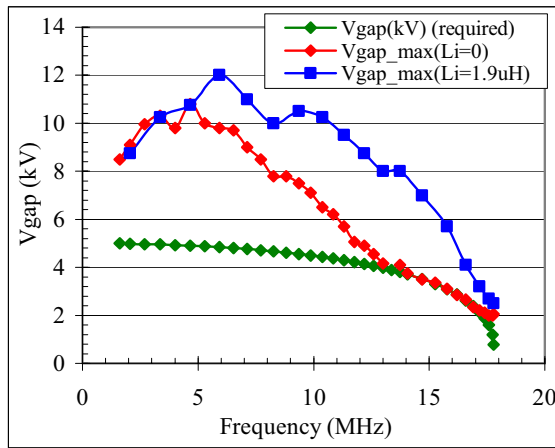

Figure 8: Obtained maximal gap voltage as function of frequency.

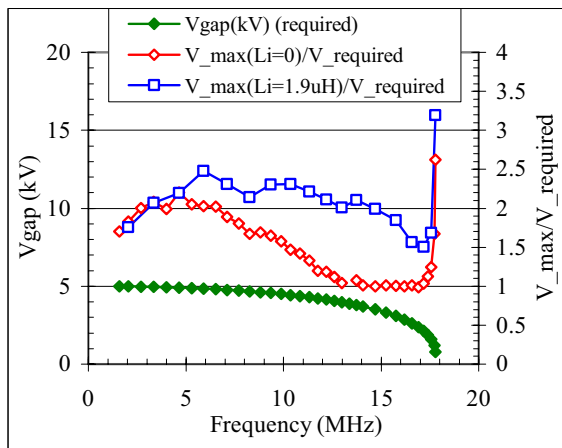

Figure 9: Ratio of obtained maximal gap voltage to the required gap voltage as function of frequency.

In order to improve the frequency response of rf system, an inductor ( $L_i$ ) of  $1.9\mu\text{H}$  is inserted between the cavity and amplifier tube [7]. And then we take the data of maximal gap voltage as shown in the blue curve in Fig. 8. The ratio of obtained maximal gap voltage to required gap voltage is shown in Fig. 9. From the above experiments, the performance of the rf system is successfully improved, exactly agreeing with the calculation results. Fig. 10 shows the obtained maximal acceleration gradient as function of frequency. The maximal gradient reaches  $60\text{kV/m}$  at  $5.91\text{MHz}$ . Fig. 11 shows the waveforms of gap voltage of  $12\text{kV}$  at  $5.91\text{MHz}$ .

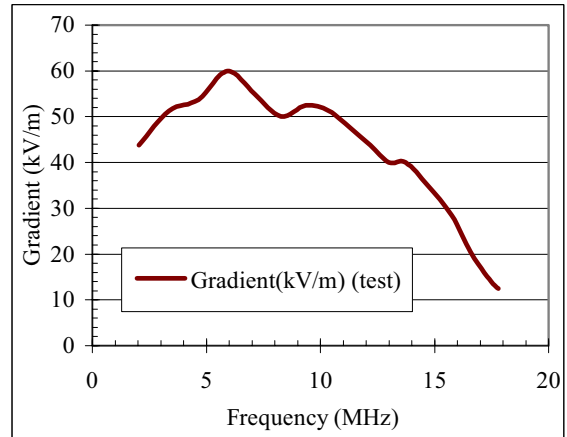
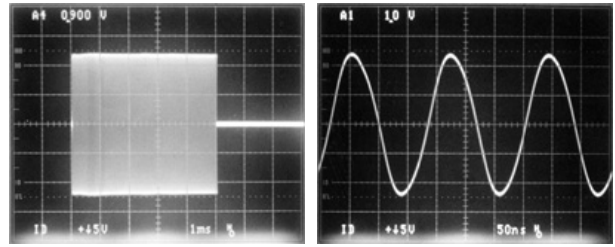

Figure 10: Obtained maximal acceleration gradient as function of frequency.



a)  $5\text{V}/\text{div} \times 1000$ ,  $1\text{ms}/\text{div}$ . b)  $5\text{V}/\text{div} \times 1000$ ,  $50\text{ns}/\text{div}$ .  
Figure 11: Waveforms of gap voltage of  $12\text{kV}$  at  $5.91\text{MHz}$ .

## SUMMARY

The rf system for the compact proton synchrotron has been developed. And the high power test has been successfully performed to achieve the required gap voltage. More tests of the rf system with the low-level control system will be performed.

## REFERENCES

- [1] K. Endo et al, "Compact Proton and Carbon Ion Synchrotrons for Radiation Therapy", EPAC 2002, 2733-2735, France.
- [2] K. Endo et al, "Development of High Field Dipole and High Current Pulse Power Supply for Compact Proton Synchrotron", PAC 2003, 1071-1073, USA.
- [3] K. Endo et al, "Development of Compact Proton Synchrotron for Radiation Therapy", ARTA 2003, 51-54, Japan.
- [4] K. Endo et al, "High Field Pulse Dipole and Quadrupole Magnets for Compact Medical Pulse Synchrotron", APAC 2004, Korea.
- [5] K. Endo et al, "Compact Synchrotron for Radiotherapy Based on Pulse Technology", ARTA 2004, 7-10, Japan.
- [6] Z. Fang et al, "Test Results of RF Cavity and Power Amplifier for Compact Medical Proton Synchrotron", APAC 2004, Korea.
- [7] Z. Fang et al, "RF Cavities and Power Amplifier for the Compact Proton Synchrotron", PAC 2003, 1074-1076, USA.